

TOCSIN 102 4-20mA 2 Wire Gas Transmitter.

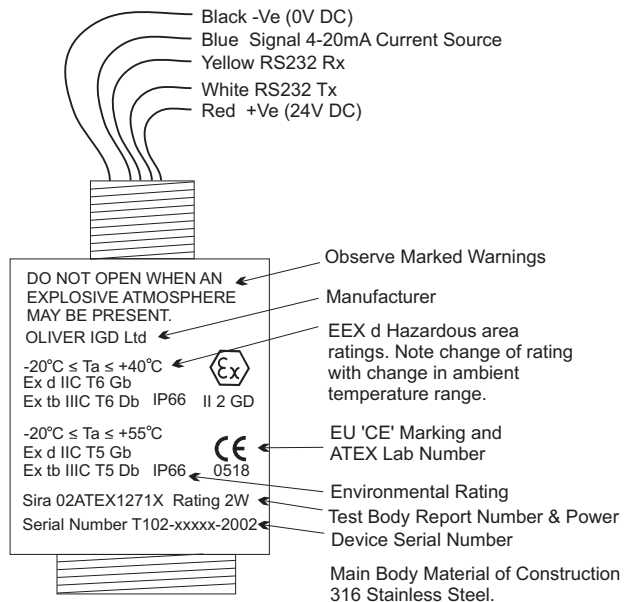

Explanation of Markings

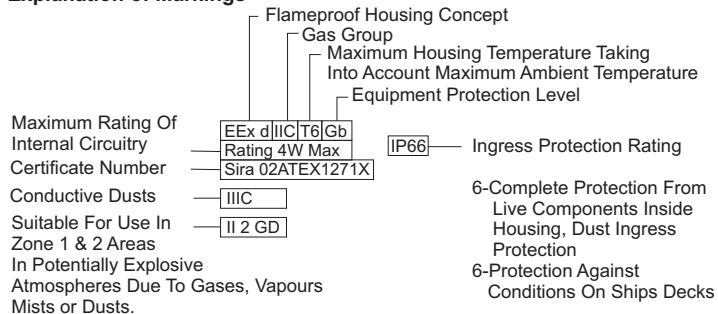

Fitting, Service and Maintenance

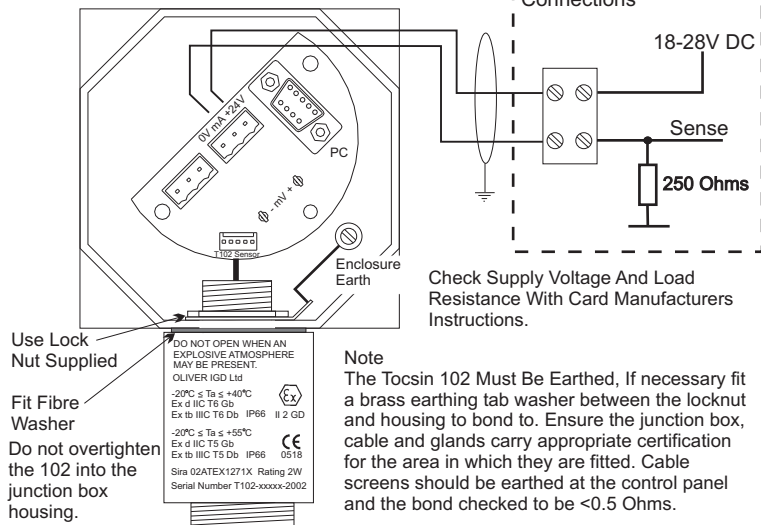

Mounting Thread
 M20 x 1.5

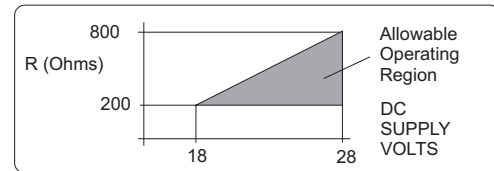

There are no user serviceable components inside the Tocsin 102.

Do not connect to portable equipment

Under no circumstances should the housing be opened in a potentially hazardous atmosphere.

Calibration should be undertaken at a minimum of six monthly intervals.

Refer to Configurator manual for more advanced options, available from Oliver IGD Limited.

TOCSIN 102 SERIES GAS DETECTORS

The Tocsin 102 series of gas detectors are ATEX approved sensors which incorporate micro processor technology to give a stable 4-20mA process signal output. The addressable option allows extensive reductions in cost of installation through material and labour savings. The in built processor can be used to pre-calibrate the sensor prior to installation. A range of sensing technologies can be incorporated into the housing to provide the most appropriate detection method. Available sensor types include Infra red and Electrochemical and PID devices.

Oliver IGD offer a comprehensive range of control panel options for both safe area and ATEX operation. Please refer to Oliver IGD limited for further details.

www.oliver-igd.co.uk

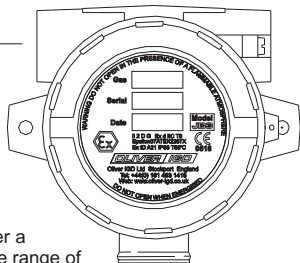

Standard Junction Box EEXd	5045801
Stainless Steel Junction Box EEXd	5045802
Polyester Junction Box EXE	5045803

Tocsin 102 Part Numbers: (Add suffix 'A' for addressable versions)		
Flammable Gases Infra Red	5107901	A
Carbon Monoxide	5107101	A
Nitric Oxide	5106801	A
Nitrogen Dioxide Infra Red	5106301	A
Hydrogen Cyanide	5107201	A
Chlorine	5106601	A
Ozone	5106201	A
Hydrogen Sulphide	5106501	A
Ammonia	5107001	A
Oxygen	5106701	A
Sulphur Dioxide	5106401	A
Hydrogen Chloride	5106101	A

Technology	Used to Monitor	Available Ranges																							
Infra-Red	Most Flammable Gases, Vapours And Carbon Dioxide, Typically:																								
	<table border="0"> <tr> <td>Methane</td> <td>Ethanol</td> <td>ppm and % Ranges Available</td> </tr> <tr> <td>Propane</td> <td>Iso Propyl Alcohol</td> <td></td> </tr> <tr> <td>n-Butane</td> <td>Acetone</td> <td></td> </tr> <tr> <td>n-Pentane</td> <td>Methyl Ethyl Ketone</td> <td></td> </tr> <tr> <td>n-Hexane</td> <td>Benzene</td> <td></td> </tr> <tr> <td>Methanol</td> <td>Toluene</td> <td></td> </tr> <tr> <td>Carbon Monoxide</td> <td>CO₂</td> <td></td> </tr> <tr> <td>SF₆</td> <td>Freons</td> <td></td> </tr> </table>	Methane	Ethanol	ppm and % Ranges Available	Propane	Iso Propyl Alcohol		n-Butane	Acetone		n-Pentane	Methyl Ethyl Ketone		n-Hexane	Benzene		Methanol	Toluene		Carbon Monoxide	CO ₂		SF ₆	Freons	
Methane	Ethanol	ppm and % Ranges Available																							
Propane	Iso Propyl Alcohol																								
n-Butane	Acetone																								
n-Pentane	Methyl Ethyl Ketone																								
n-Hexane	Benzene																								
Methanol	Toluene																								
Carbon Monoxide	CO ₂																								
SF ₆	Freons																								
Electrochemical	Most Common Toxic Gases And Oxygen Typically:																								
	<table border="0"> <tr> <td>Carbon Monoxide</td> <td>Oxygen</td> <td>ppm and % Ranges Available</td> </tr> <tr> <td>Nitric Oxide</td> <td>Hydrogen Sulphide</td> <td></td> </tr> <tr> <td>Nitrogen Dioxide</td> <td>VOC's</td> <td></td> </tr> <tr> <td>Hydrogen Sulphide</td> <td></td> <td></td> </tr> <tr> <td>Sulphur Dioxide</td> <td></td> <td></td> </tr> </table>	Carbon Monoxide	Oxygen	ppm and % Ranges Available	Nitric Oxide	Hydrogen Sulphide		Nitrogen Dioxide	VOC's		Hydrogen Sulphide			Sulphur Dioxide											
Carbon Monoxide	Oxygen	ppm and % Ranges Available																							
Nitric Oxide	Hydrogen Sulphide																								
Nitrogen Dioxide	VOC's																								
Hydrogen Sulphide																									
Sulphur Dioxide																									
PID	Low Level Monitoring of a wide Range of Toxic and Flammable Gas Hazards Typically:	ppb and ppm Ranges Available																							
	VOC's (Volatile Organic Compounds) TIC's (Toxic Industrial Chemicals) CWA (Chemical Warfare Agents) Hydrocarbons Fumigants																								

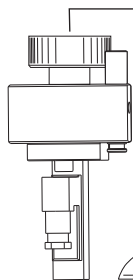

Weather Protection Assembly And Test Gas Applicator 401451

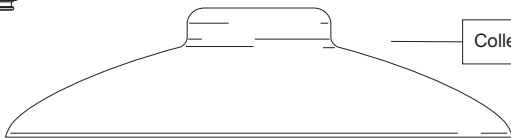

Collector Cone 401061



Test Gas Applicator/Flow Cell 401101A



Test Gas Applicator Clamp Ring 401101E

Modular Sampler EMS1 5799101
For the full range of available adaptors see data sheet IGD-DA-003

Oliver IGD Limited Reserve the right to amend specifications without prior notice

Ref INFO215

OLIVER IGD LIMITED

4a Pepper Road, Hazel Grove
Stockport, SK7 5BW, England

Tel +44 (0)161 483 1415
Fax +44 (0)161 484 2345
Email sales@oliver-igd.co.uk